

Roof Lantern

Installation Guide

TB431

JUNE 2024

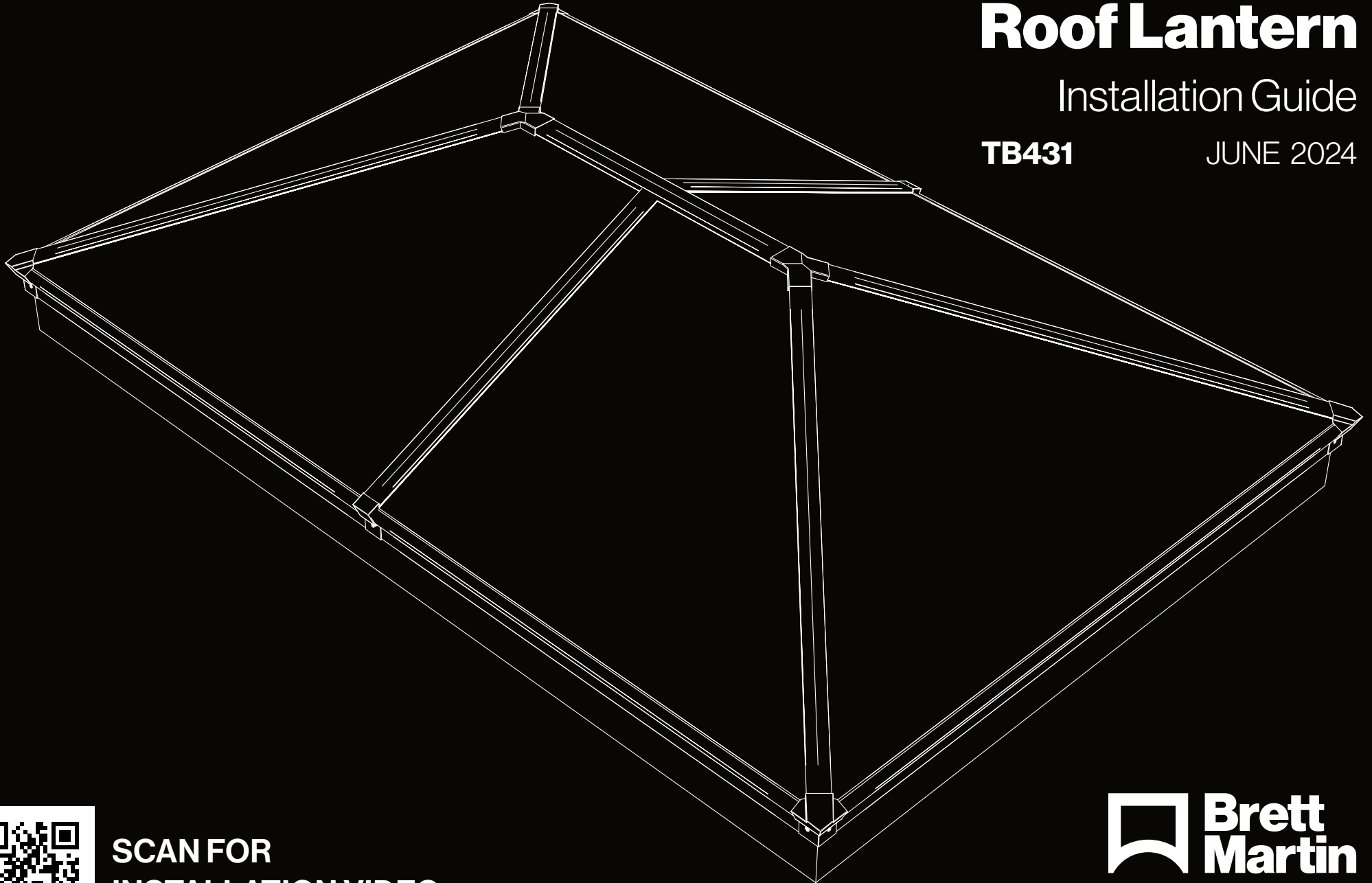

SCAN FOR
INSTALLATION VIDEO



Upstand Requirements

Construct finished, insulated and weathered builder's upstand to dimensions shown.

Roof covering must cover **side and top** of insulated upstand in accordance with manufacturer's installation recommendations. There should be no excessive build-up of layers, and the top surface should be level and free from protrusions or projections which may prevent adequate weatherproofing.

Roof Lantern rooflights are intended for installation onto a fully weathered and insulated builder's upstand on flat and low pitch roofs. The surface of flat roofs normally require some degree of pitch to ensure adequate water runoff. For aesthetic reasons we recommend that the upstand is built with 0° pitch i.e. not parallel with the pitched roof surface. The rooflight can accommodate being installed on an upstand with a pitch of up to 5° but please note that this will likely result in a 'lopsided' appearance.

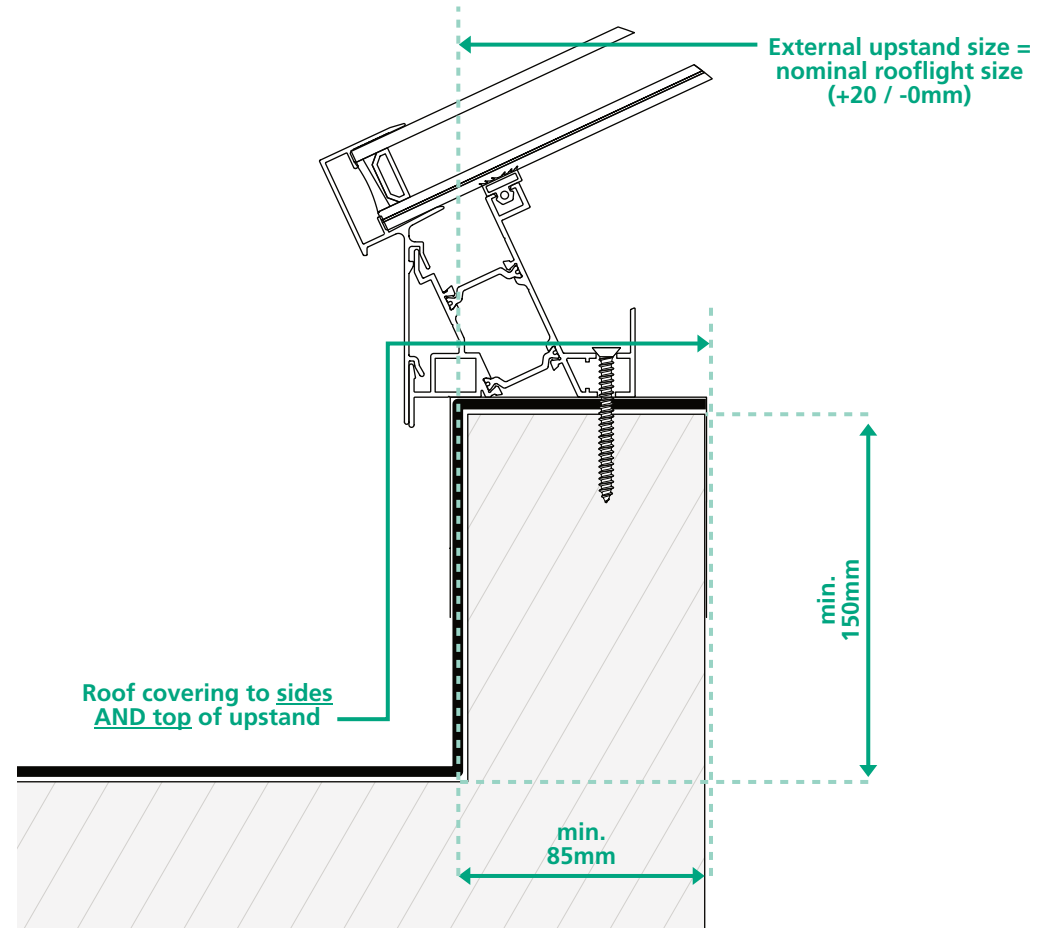
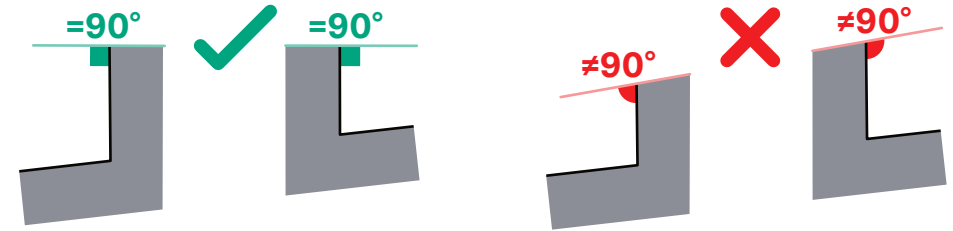
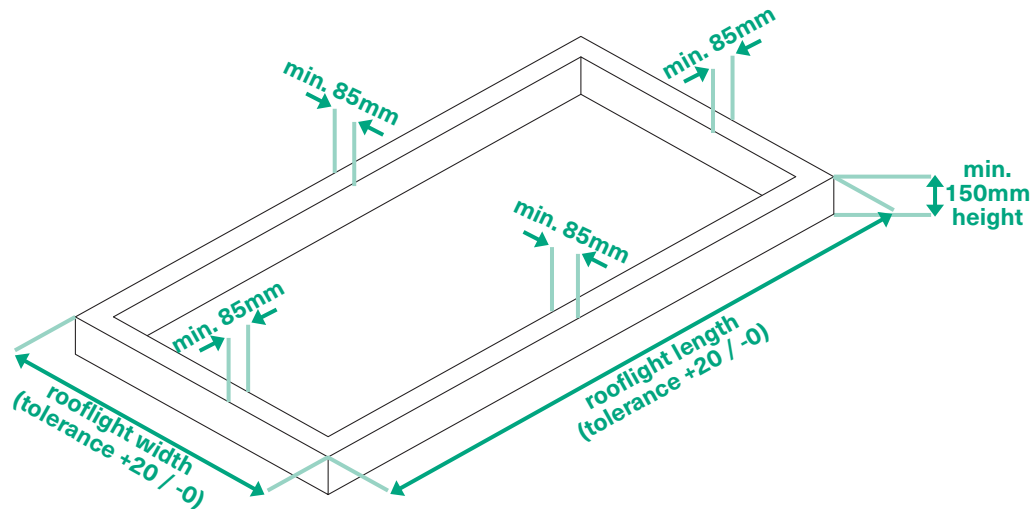

Health & Safety



Warning: this product is designed for installation by professional roofing installers, who are responsible for establishing a safe method of work. All risks involved, including those involved in roof access and working around (and if necessary across) an open roof aperture must be assessed, and suitable precautions taken to minimise those risks, with a safe method of work established and documented for each project.

Instructions must be followed **carefully** and in the correct order otherwise warranty may be invalidated.



IMPACT DRIVERS MUST NOT BE USED

Technical Support

For any technical information/queries please contact your supplier. The manufacturer operates a policy of continuous product improvement, and reserves the right to alter specifications at any time without notice. Every effort has been taken to ensure all details contained in this document are correct at the time of going to press but this document should be used only as a guide and does not in any way form part of a contract or warranty. It is the customer's responsibility to ensure that the product is suitable for the actual conditions of use, which are beyond the control of the manufacturer

Safety Equipment Required



Safety Gloves
Cut level 5 or E gloves

Required as per following standards
EN 288; EN ISO 21420

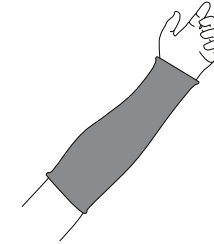

Cut Resistant
Sleeves

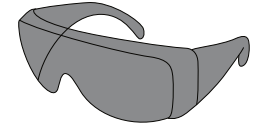

Safety Glasses

Tools Required

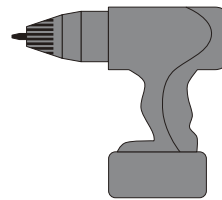

Electric
Screwdriver
NO IMPACT DRIVERS

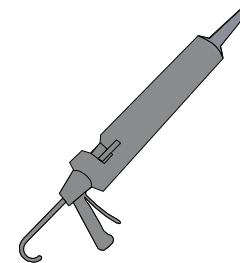

Sealant

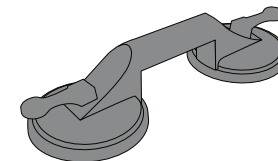

Glass Sucker(s)
Recommended for
larger sizes

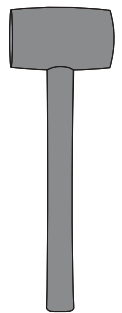

Rubber Mallet

Contents

Components Box (only use fixings supplied)

30 x
50mm Kerb Screws

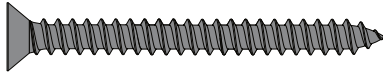

8 x
M6x40mm
Kerb Bolts

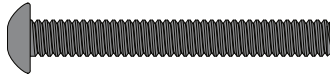

4 x
M6x40mm
Hip Bolts

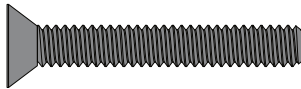

2 x
M6x25mm
Glazing Clamp Bolts



8 x
No. 10x25mm
Outer Cap Screws

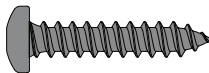

16 x
M6x10mm
Corner Cleat Bolts

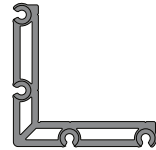

8 x
Corner Cleat

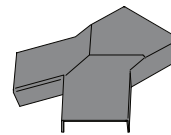

2 x
Ridge Cap

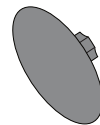

30 x
Kerb Screw Cap

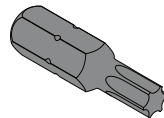

1 x
T-25 Torx
Driver Bit

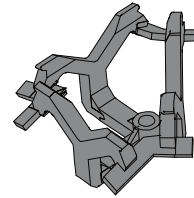

2 x
Glazing Clamp

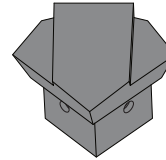

4 x
Hip Cap

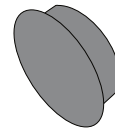

8 x
Cover Cap

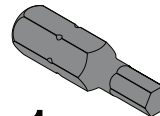

1 x
4mm Hex
Driver Bit

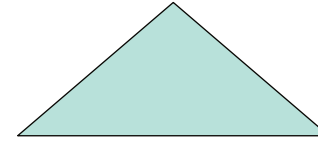

2 x
Glass Triangle

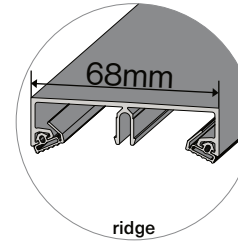

1 x
Ridge Outer

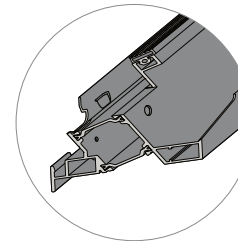

4 x
Kerb Bar

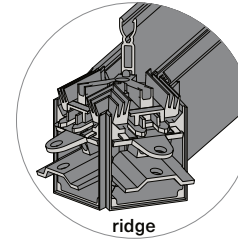

1 x
Ridge Inner



2 x
Glass Trapezium
(4 pane option only)

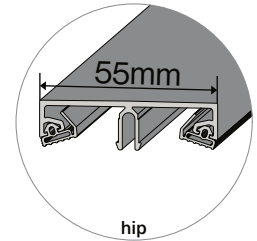

4 x
Hip Outer

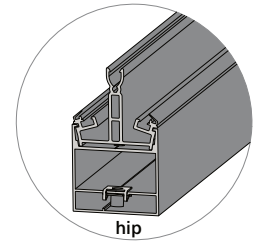

4 x
Hip Inner

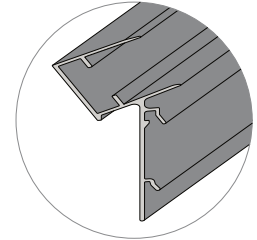

4 x
Glass Stop

Additional contents - 6 pane option only

Components Box

+ 2
M6x40mm
Kerb Bolts

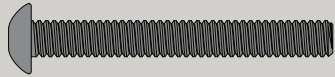

2 x
M6x35mm
Rafter Bolts
(black bolt)

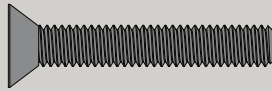

+2
No. 10x25mm
Outer Cap Screws

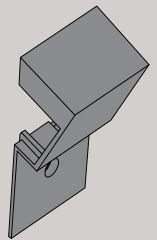
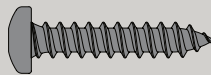

2 x
Rafter Cap

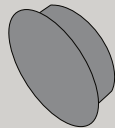

+ 2
Cover Cap

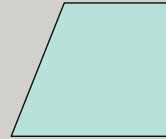

2 x
Left Glass Trapezium

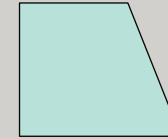

2 x
Right Glass Trapezium

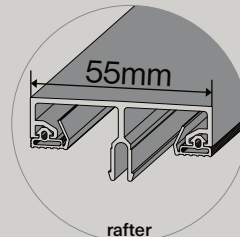

rafter
2 x
Rafter Outer

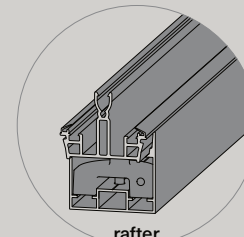

rafter
2 x
Rafter Inner

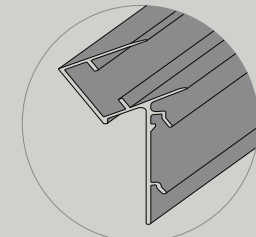

+ 2
Glass Stop

1. Assemble base frame

x 16

M6x10mm
Corner Cleat Bolts

x 8

Corner Cleat

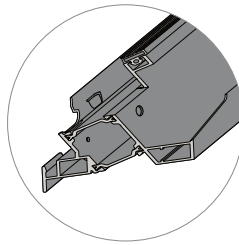

x 4

Kerb Bar

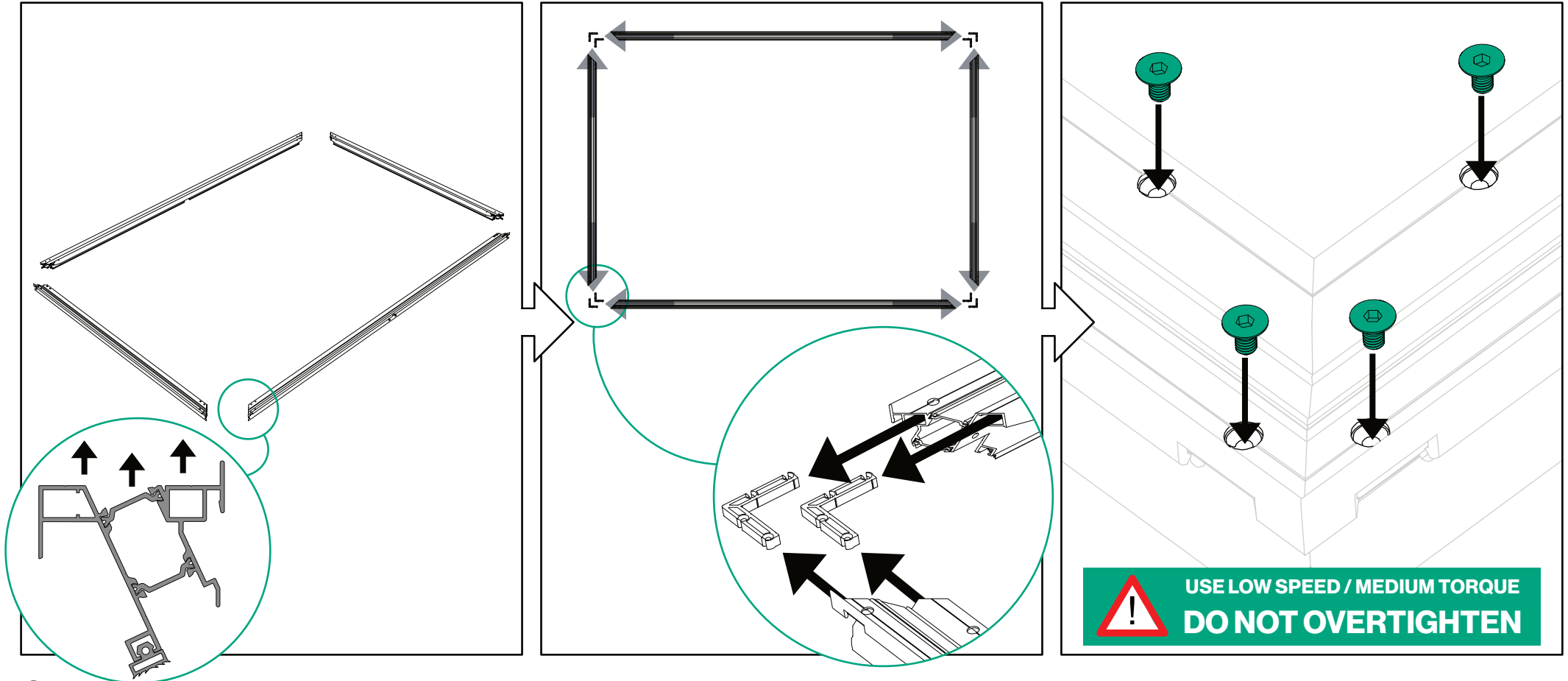

2. Apply sealant then rotate and position frame on upstand

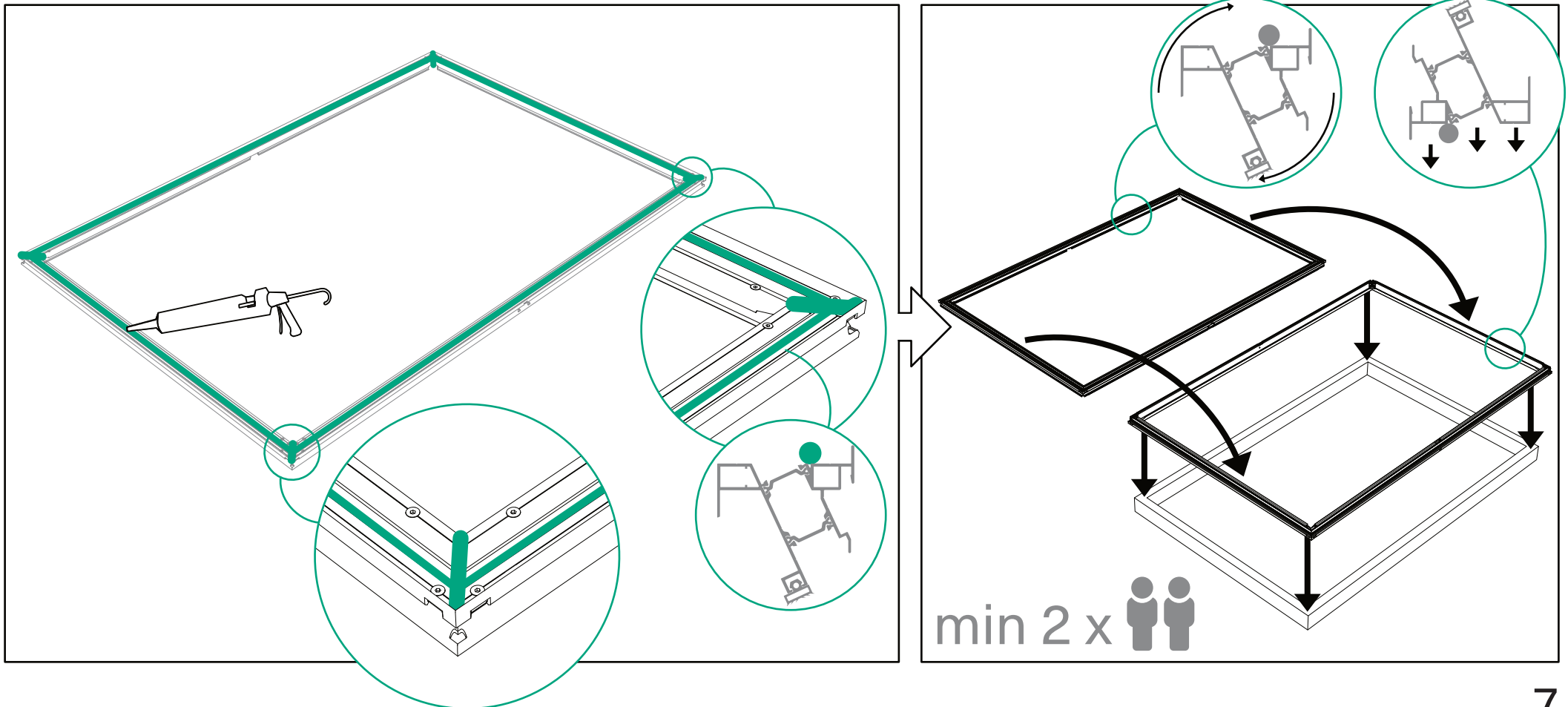

3. Connect spider frame

 x 4
M6x40mm
Hip Bolts

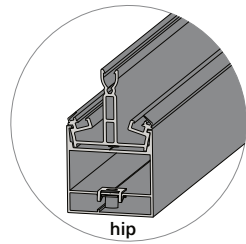
 x 4
Hip Inner

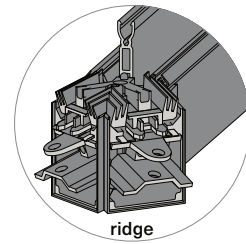
 x 1
Ridge Inner

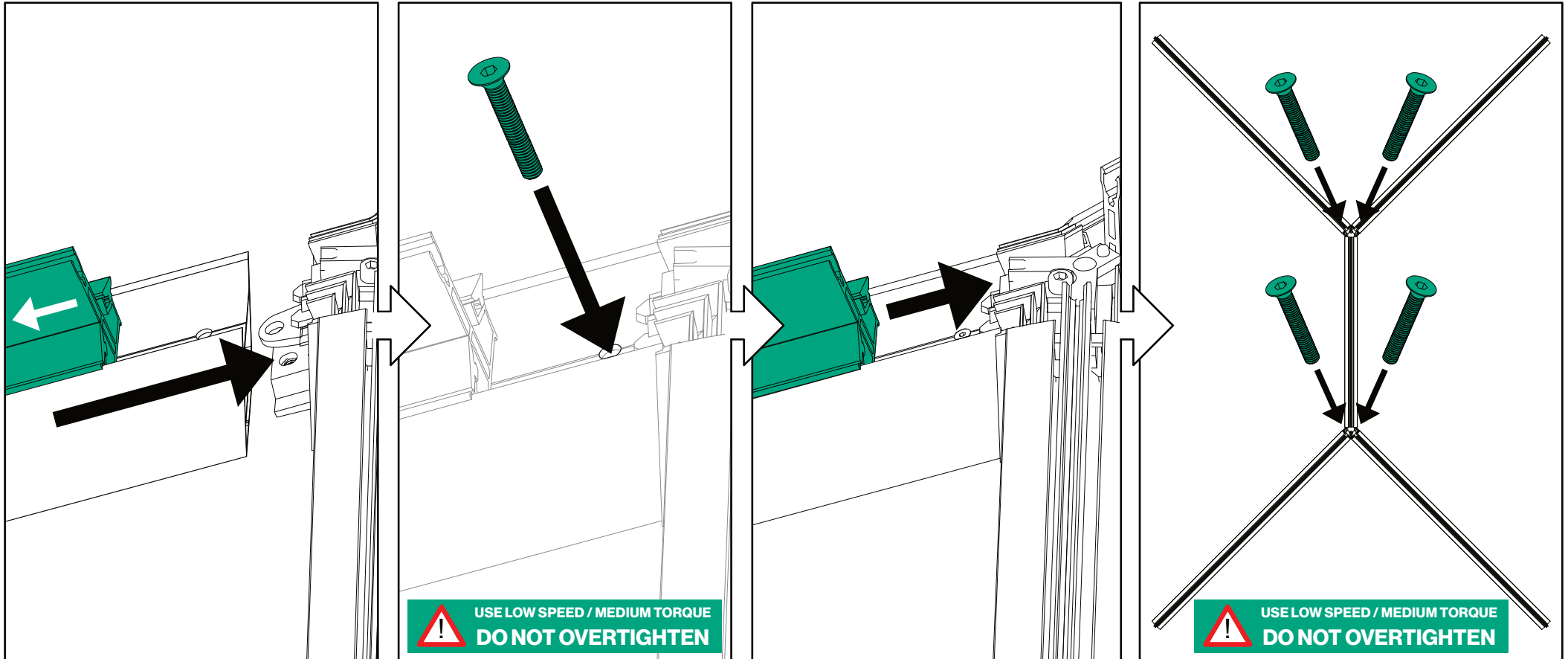

6 pane option only

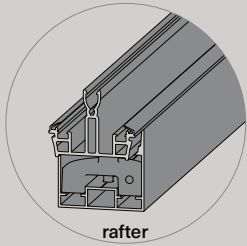

x 2
Rafter Inner

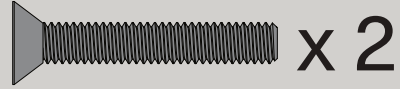

x 2
M6x35mm
Rafter Bolts
(black bolt)

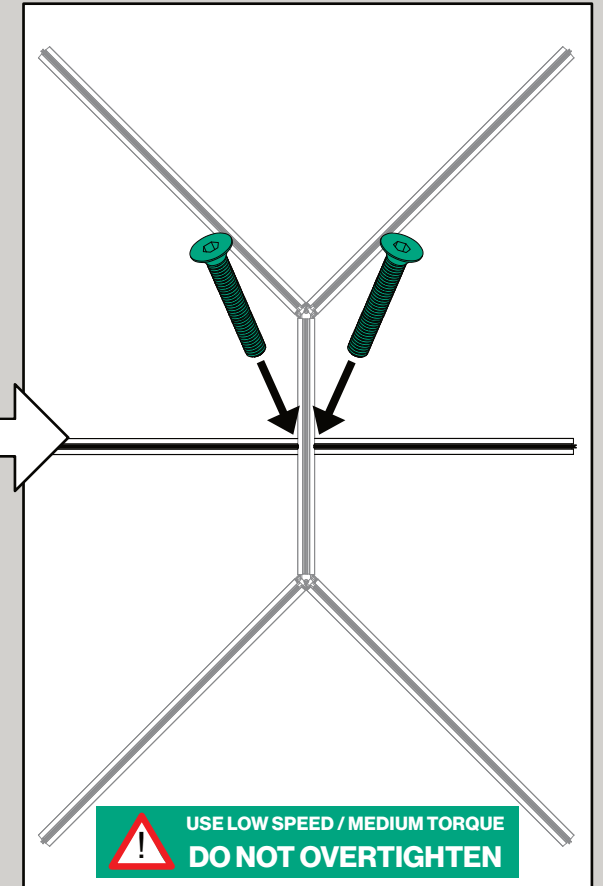
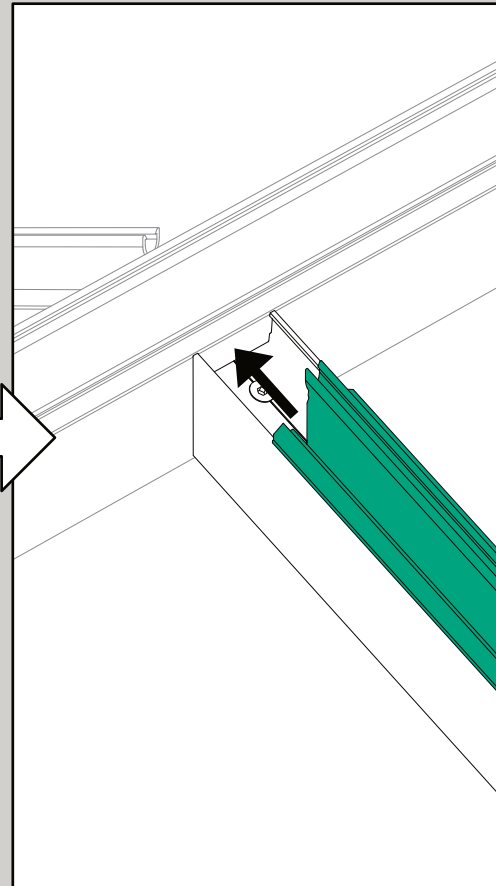
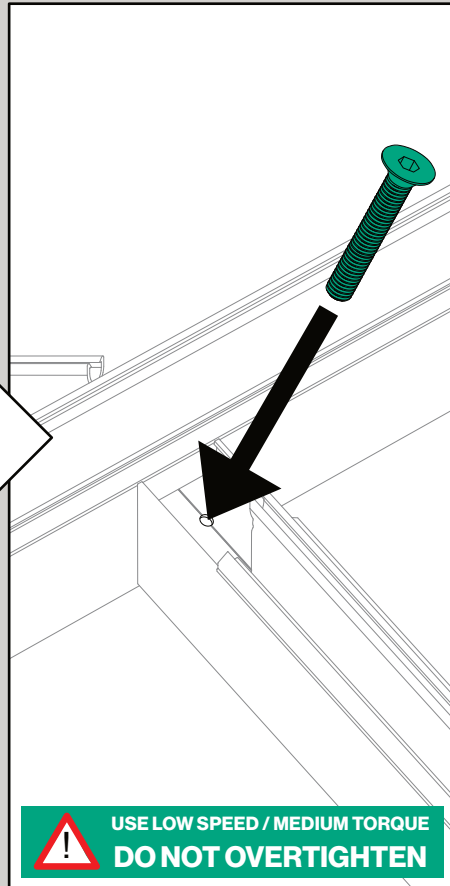
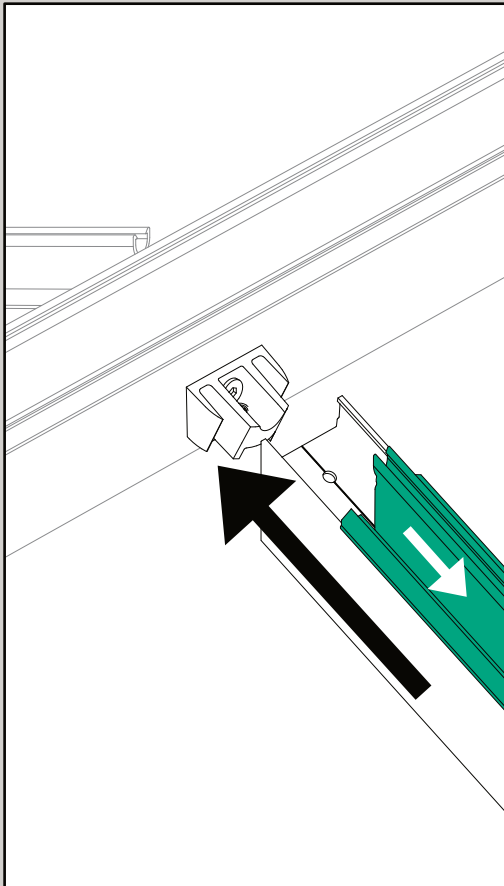

4. Fit spider frame to base frame

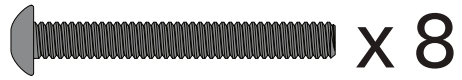

M6x40mm
Kerb Bolts

6 pane option only

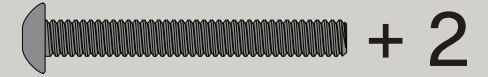

M6x40mm
Kerb Bolts

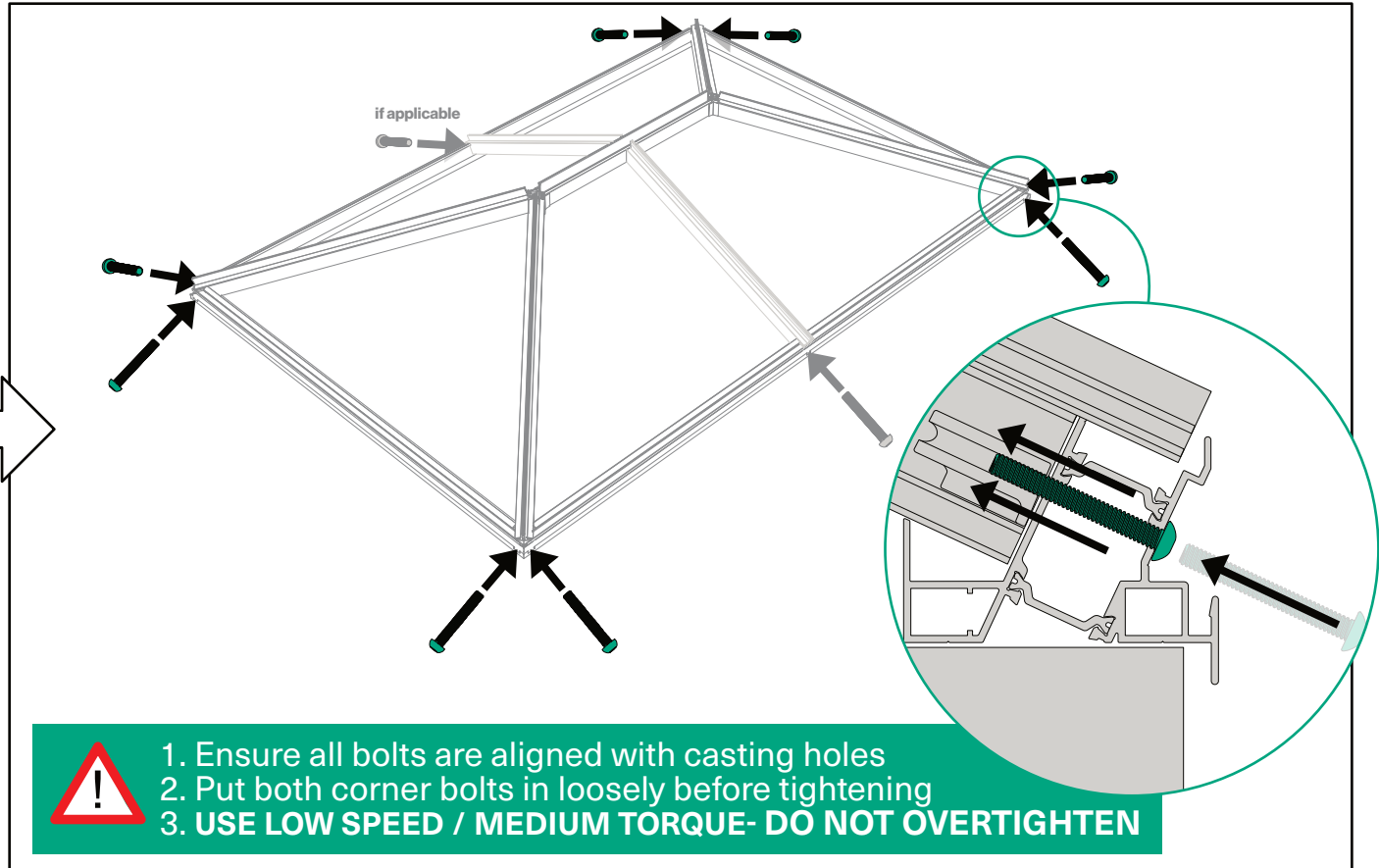
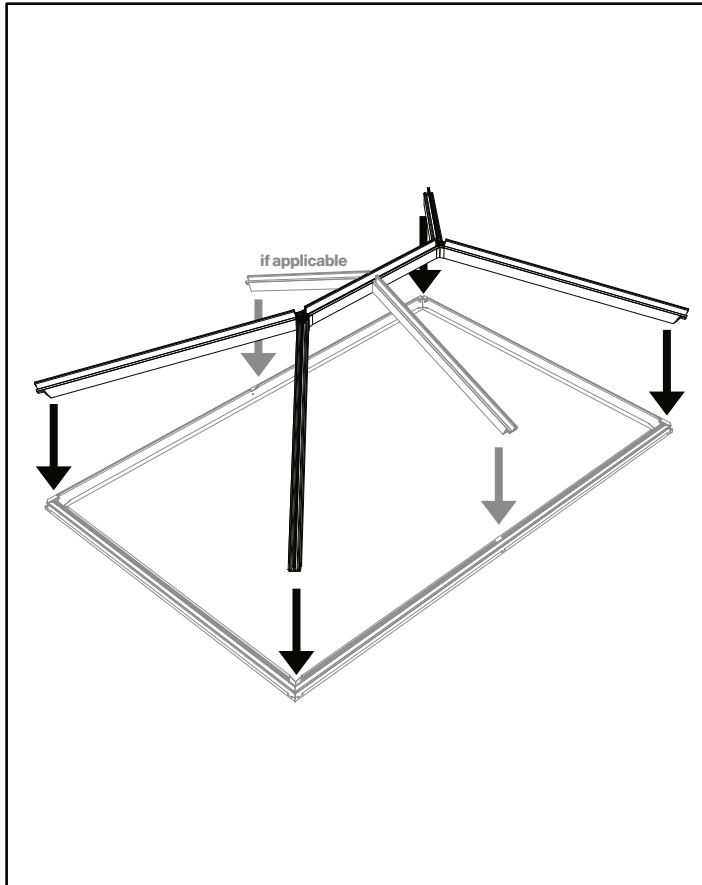

5. Fix unit to upstand through pre-drilled holes

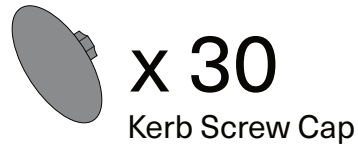

N.B. Roof Lantern is supplied with the maximum fixings required. Smaller sizes will have surplus screws.

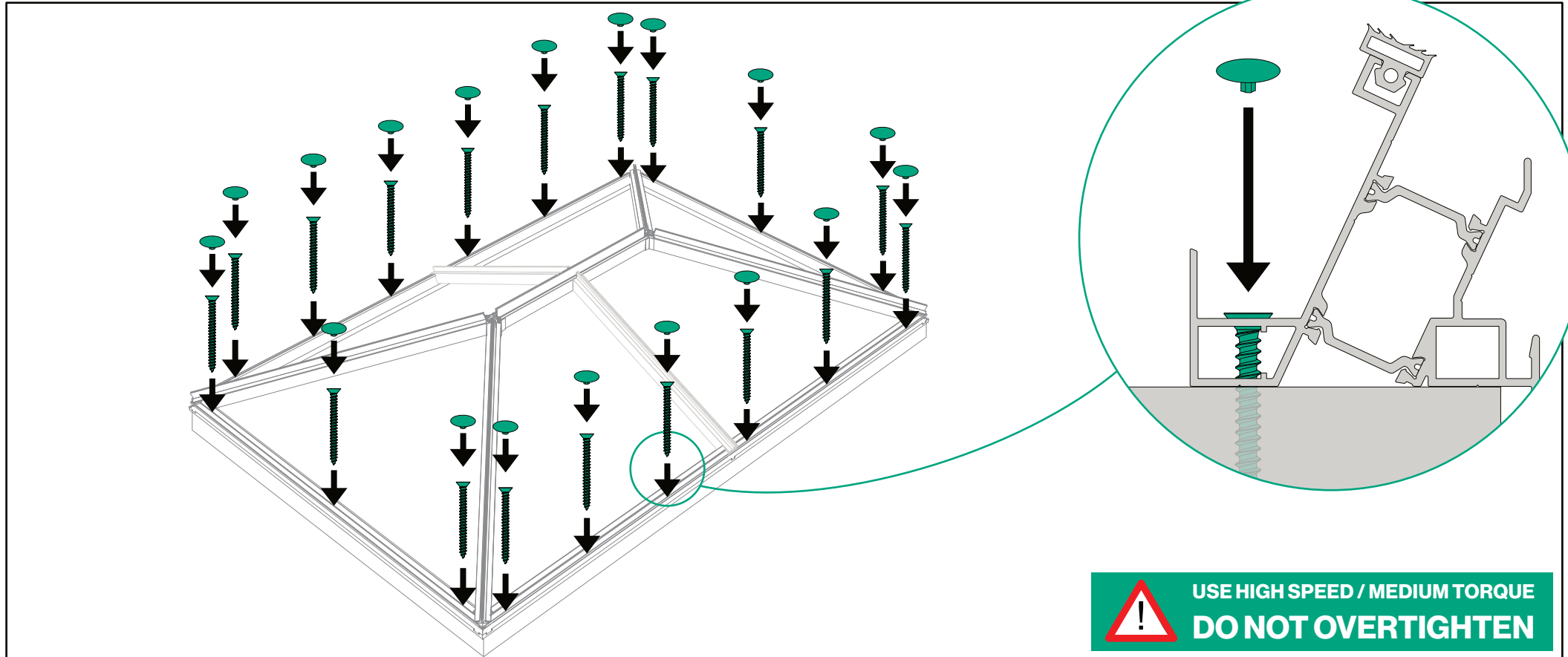

 **USE HIGH SPEED / MEDIUM TORQUE
DO NOT OVERTIGHTEN**

6. Prepare glass

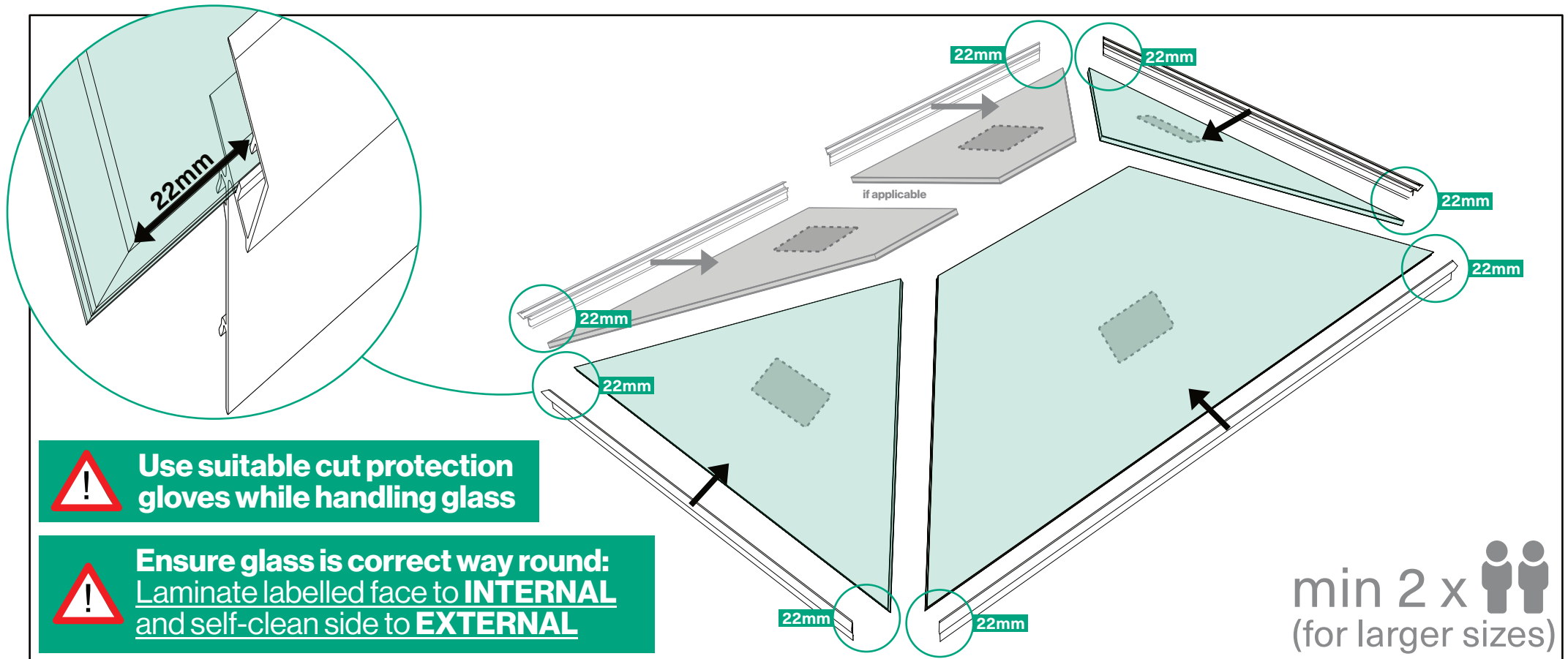
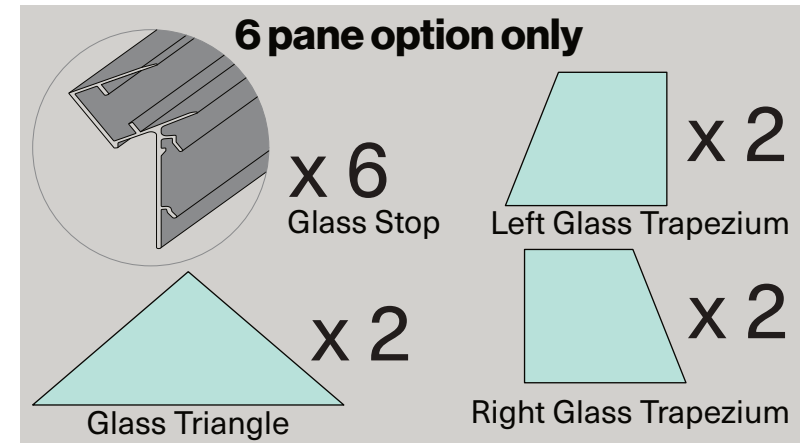
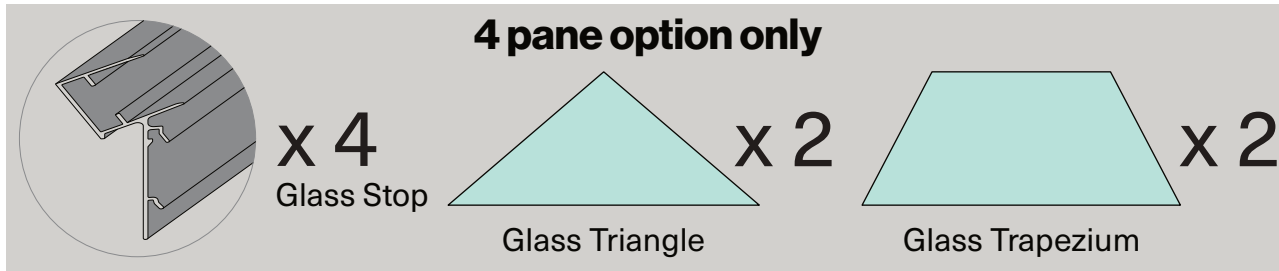

 Use suitable cut protection gloves while handling glass

 Ensure glass is correct way round: Laminate labelled face to **INTERNAL** and self-clean side to **EXTERNAL**

min 2 x  (for larger sizes)

7. Fit glass to frame and align corners

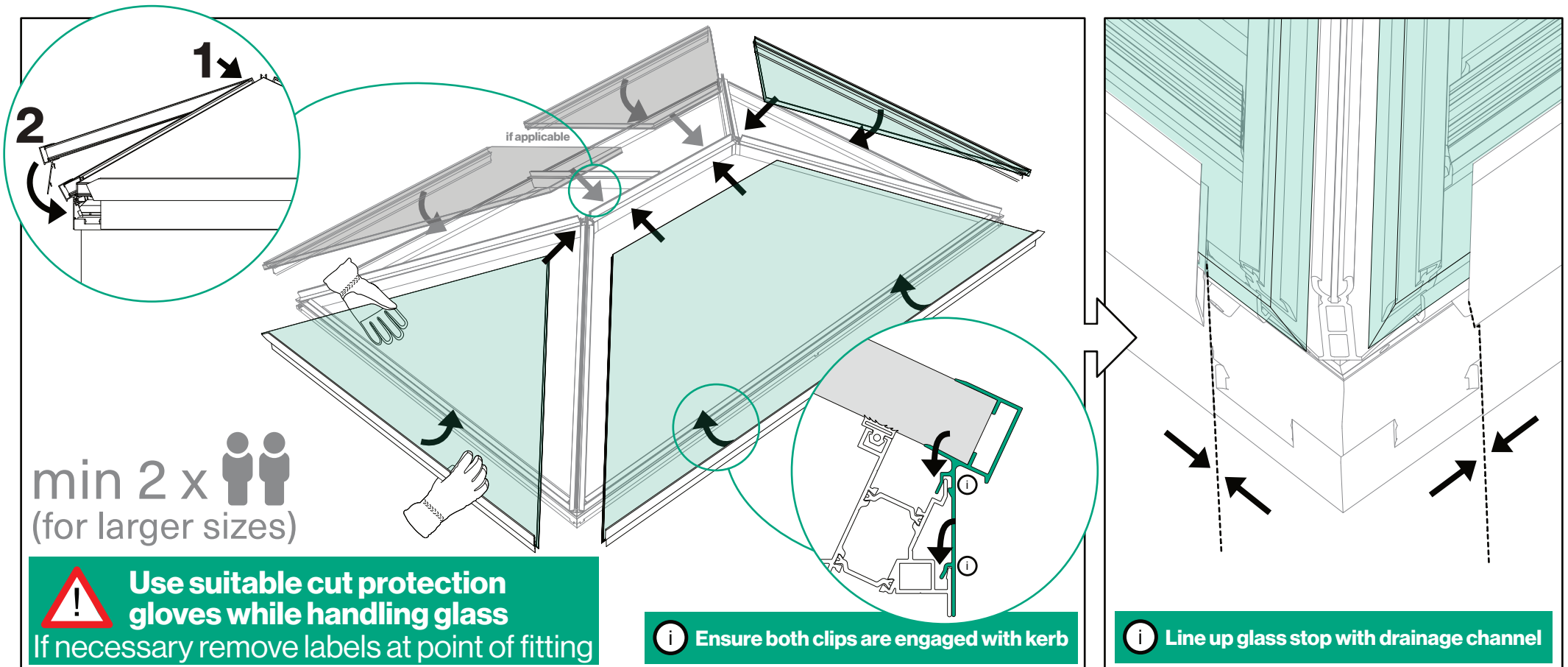

8. Position glazing clamps

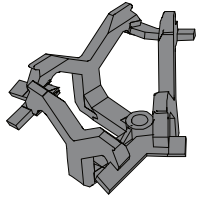

x 2

Glazing Clamp

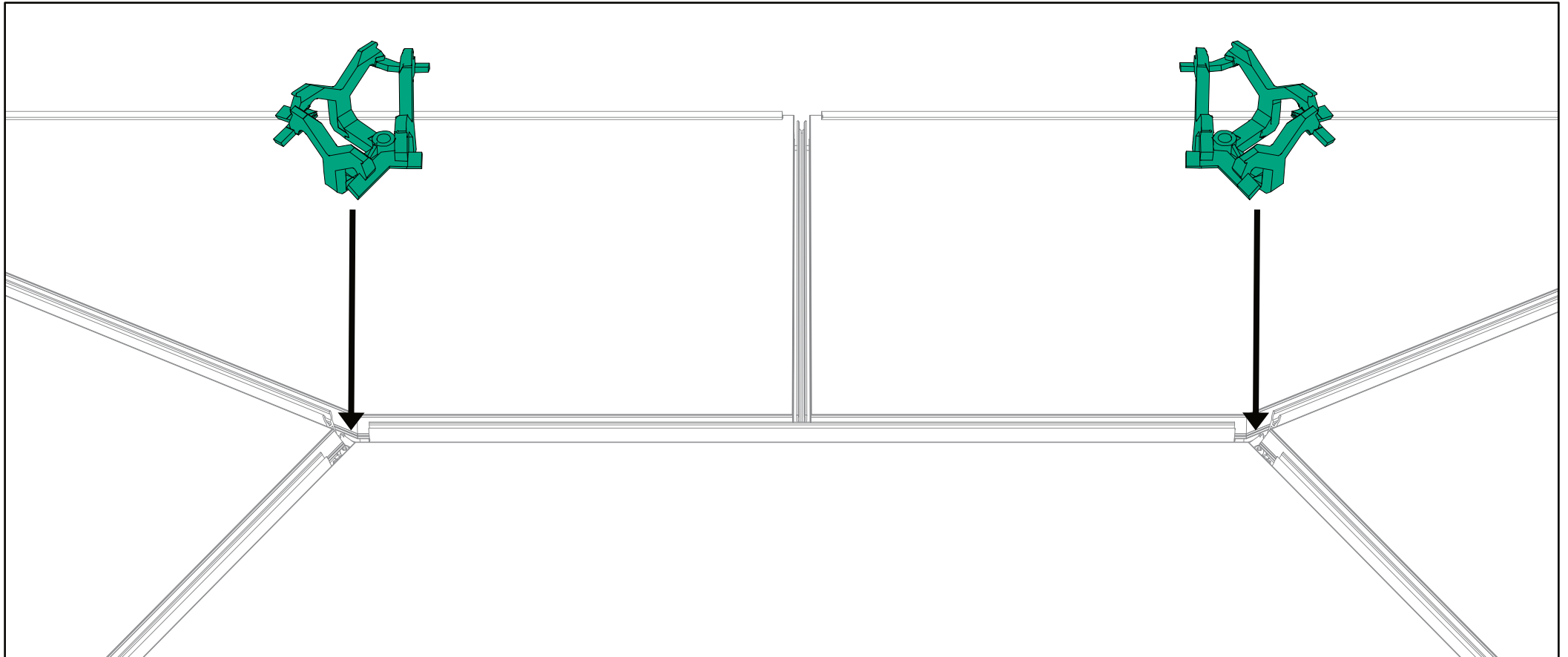

10. Align and clip on ridge outer then fix down glazing clamps

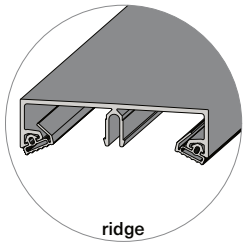

x 1
Ridge Outer



x 2
M6x25mm
Glazing Clamp Bolts

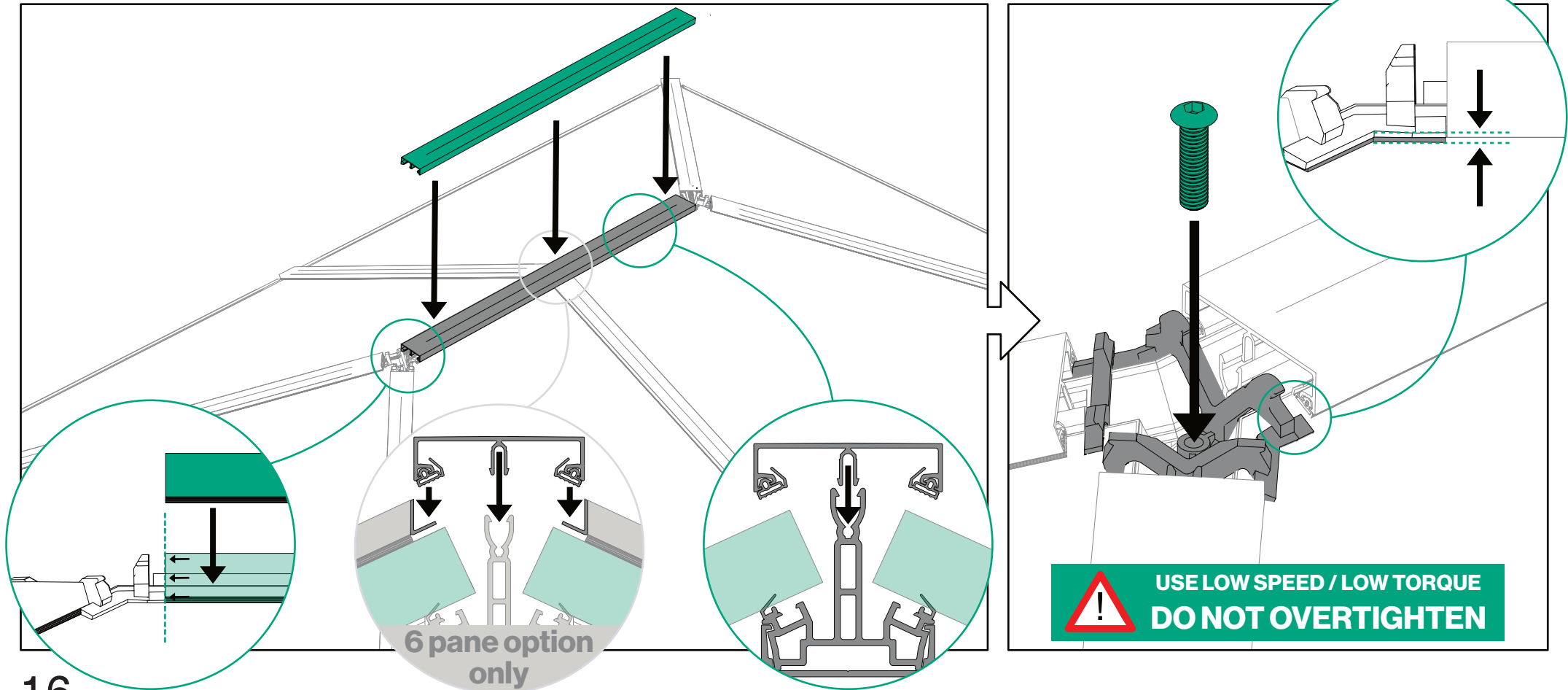

11. Clip on ridge caps

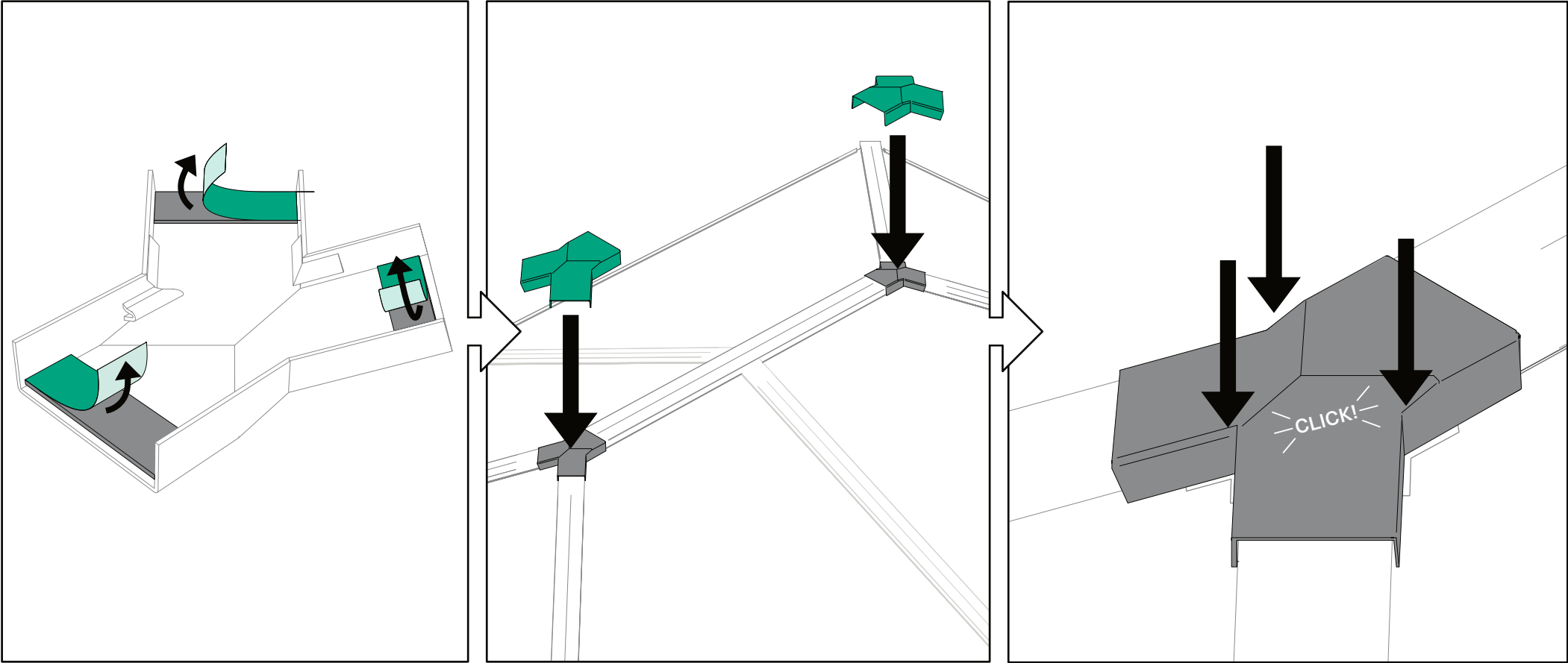
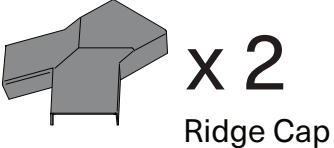

12. Attach hip caps

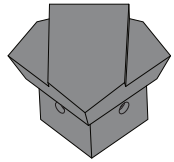

x 4

Hip Cap

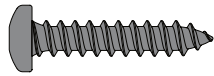

x 8

No. 10x25mm
Outer Cap Screws

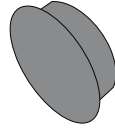

x 8

Cover Cap

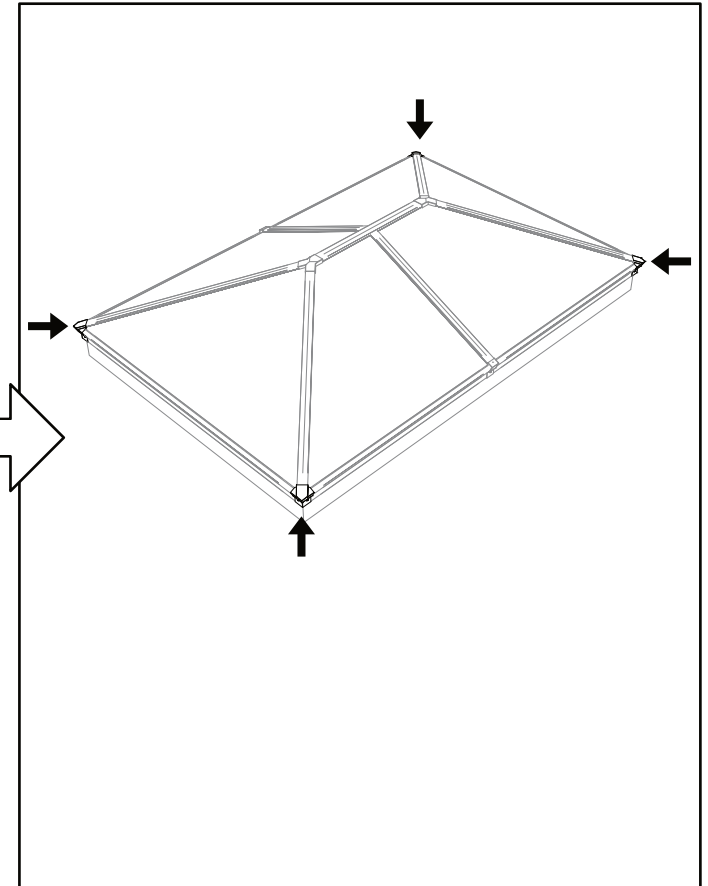
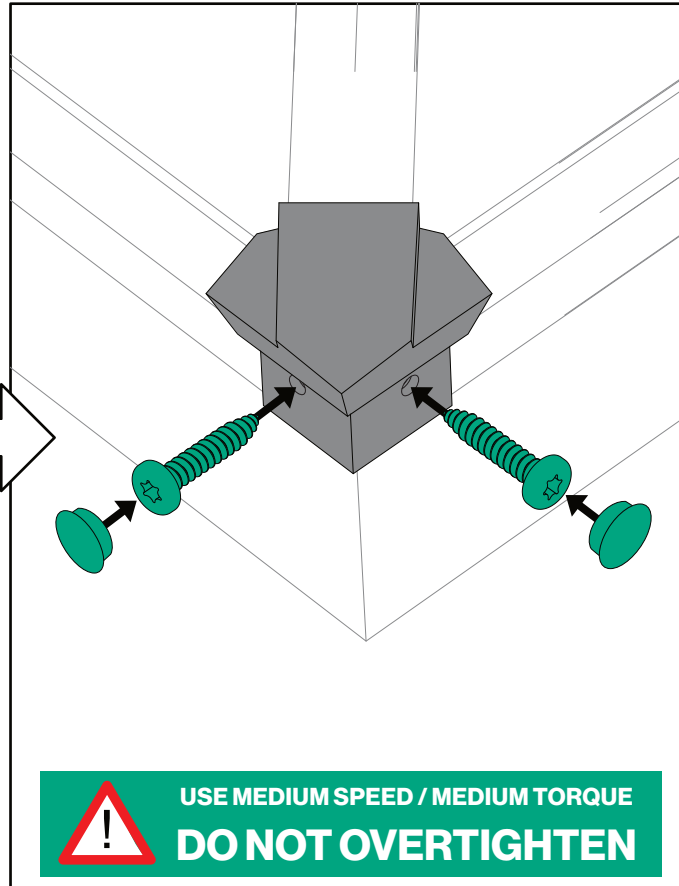
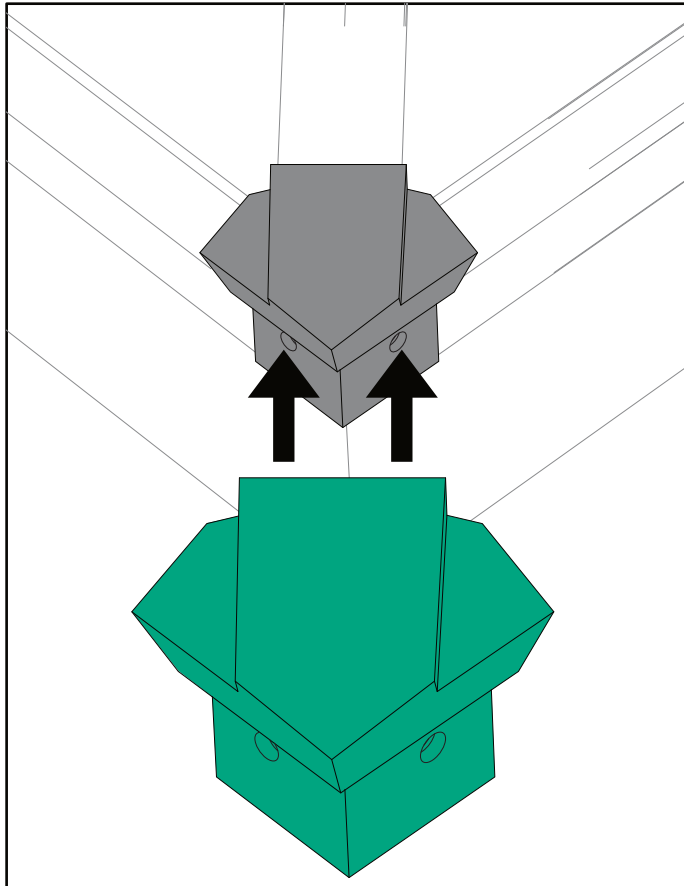

13. Attach rafter caps (6 pane option only)

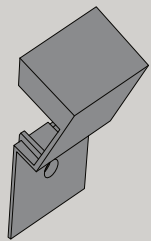

x 2
Rafter Cap

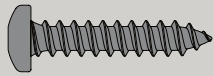

x 2
No. 10x25mm
Outer Cap Screws

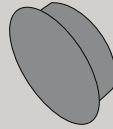

x 2
Cover Cap

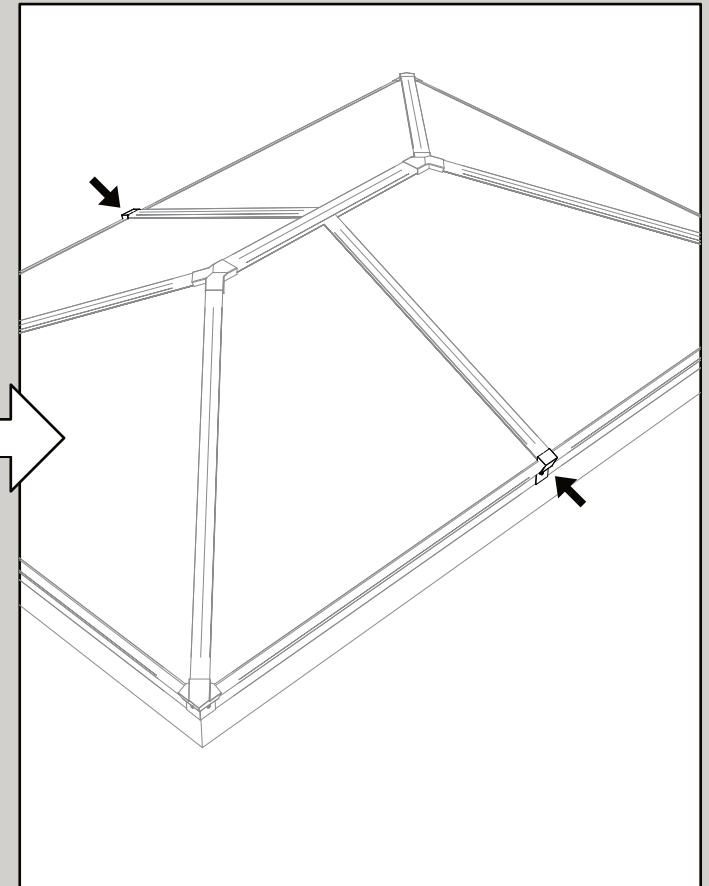
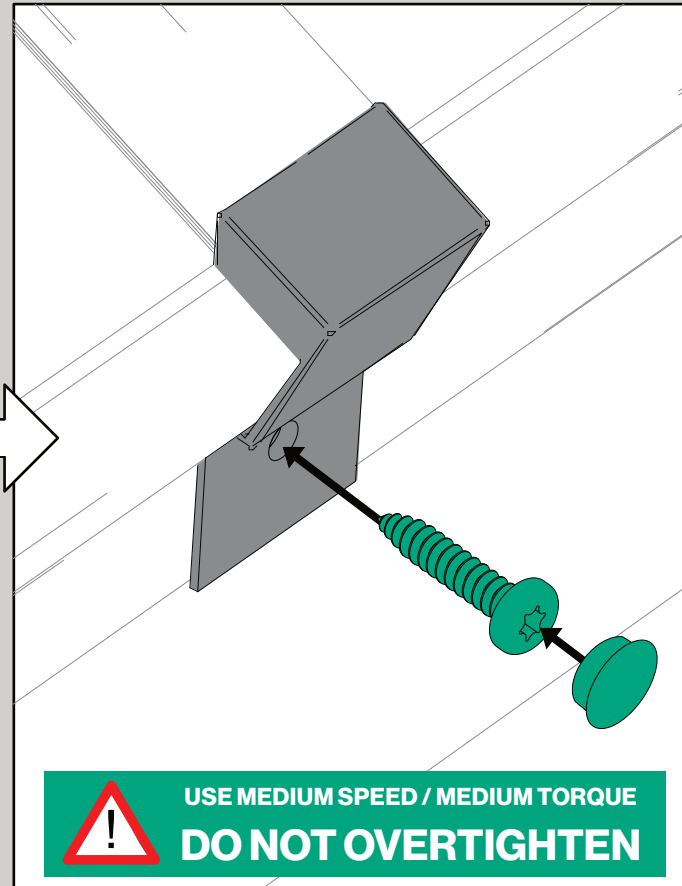
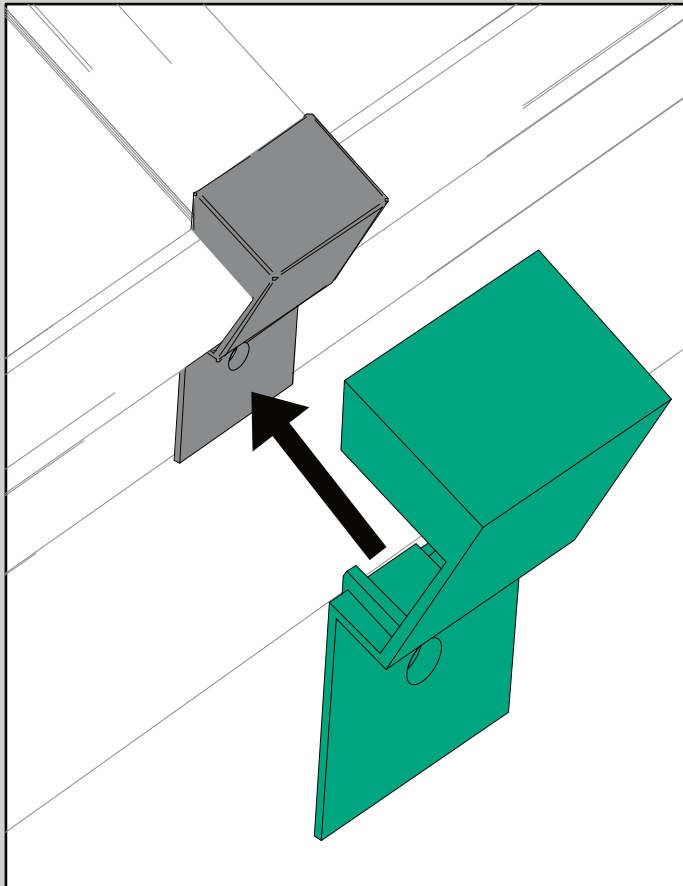



Brett Martin Daylight Systems

Sandford Close
Aldermans Green Industrial Estate
Coventry, West Midlands
CV2 2QU
t: +44 (0) 24 7660 2022
f: +44 (0) 24 7660 2745
e: daylight@brettmartin.com

For the latest information visit
brettmartin.com